

User manual



Easy Go

Van Raam
Guldenweg 23
7051 HT Varsseveld, The Netherlands

☎ +31 (0)315 – 25 73 70

✉ info@vanraam.com

🌐 www.vanraam.com

Version 24.07



Table of contents

Manufacturer contact details	3
Conformity.....	3
Introduction.....	4
Delivery.....	4
Indication.....	5
Intended usage	5
Safety measures.....	6
Adjustments of the bike.....	9
Before first use	12
Operation	16
Silent electrical system	17
Van Raam e-bike app.....	29
Accessories	30
Technical specifications	32
Standardisation and CE-marking.....	33
Maintenance and adjustments by owner.....	34
Repairs and maintenance to be done by dealer	35
Adjustments to be done by dealer.....	36
Disposal	38
Handover/sale to a new owner	38
Guarantee	38
Frame number.....	39
Maintenance recommendation	40
Delivery and service form.....	47

Manufacturer contact details

Van Raam
Guldenweg 23
7051 HT Varsseveld, The Netherlands

☎ +31 (0)315 – 25 73 70

✉ info@vanraam.com

🌐 www.vanraam.com

Conformity

Conformity Europe (CE)

Van Raam Reha Bikes B.V., as manufacturer, declares that the Easy Go, as described in this user manual, is manufactured in accordance with Regulation (EU) 2017/745, risk class 1. The Easy Go supplied with the Silent electrical system also complies with Directive 2006/42/EC including the applicable parts of EMC Directive 2014/30/EU and the NEN-EN 15194:2017 Bicycles - Electric supporting bicycles - EPAC Bicycles - part 4.2 Electrical requirements. The signed declaration of conformity can be found on the Van Raam website.

Conformity UK (UKCA)

Van Raam Reha Bikes B.V. as manufacturer declares that the Easy Go, as described in this user manual, is manufactured in accordance with the "Essential Requirements of Medical Devices Regulation 2002" (UK MDR 2002 Class 1 Medical Devices). The Easy Go supplied with the Silent electrical system also complies with the "Machinery (Safety) Directive SI 2008/1597" including the applicable parts of "Electro Magnetic Compatibility Regulations SI 2016/1091" and the NEN-EN 15194:2017 Bicycles - Electric support bicycles - EPAC Bicycles - part 4.2 Electrical requirements, excluding sections 4.2.12 and 4.2.13.. The Easy Go is provided with UKCA label according to "EU Exit Regulations 2020/1478". The signed declaration of conformity can be found on the Van Raam website.

Introduction

This user manual provides important and necessary information about the use of your scooter bike. We ask you to read this manual thoroughly before using the scooter bike.

Always follow the instructions as provided in this user manual and keep the manual carefully. The most current version of the user manual can be found on the product page of the bicycle on the website www.vanraam.com.



READ CAREFULLY

All safety and user aspects have to be made clear to children and to people with limited powers of perception by a responsible and supervising person.

Delivery

The delivery should include the following:

- Scooter bike with packing
- User manual(s)
- Possible Smart-battery including card with 5-digit code (depending on options)
- Possible chargers (depending on options)
- (Spare) keys

Check the delivery immediately after receiving it. In case of damage or incomplete delivery we ask you to contact your dealer immediately. Upon delivery you should fill out the form "Form service, maintenance, modifications and warranty claims" in the back of this manual.

Indication

The Easy Go is meant for adults with a fluctuating health status, who want to pedal but would also like to have the option of completely switching to electric engine if they cannot cycle (anymore).

Contraindication

Individuals with impaired coordination and/or strength in fingers and hands should not operate the Easy Go!

Intended usage

The Easy Go scooter bike is designed for normal use on a flat, solid surface. The Easy Go may be used at ambient temperatures ranging from -25 degree Celsius to +50 degree Celsius. In general, scooter bikes caution should always be observed when using the scooter bike. Moreover, the safety instructions as described in this manual should be explicitly followed. Local traffic laws and regulations should also be observed.

The operation of the Easy Go scooter bike differs significantly from a regular mobility scooter in several important aspects. The Easy Go is **not** equipped with an automatic brake or speed limiter. When releasing the throttle, the scooter bike will roll freely.

The brake control and braking behavior on the Easy Go also operate in scooter mode, similar to a bicycle. Therefore, the user must have sufficient strength and coordination in their hands and fingers to be able to operate the brakes at all times.

To ride the Easy Go a minimum age of 16 years is required. Besides this, the driver should be independently mobile and he/ she may not have any serious visual or other impairments, which prevent responsible participation in traffic. The maximum user weight and luggage weight (to be found in the chapter '**Technical specifications**') may not be exceeded.

The manufacturer is not responsible for any damage or injury caused as a result of or during the course of any other type of use.

Safety measures



Important: Please read the safety measures before using the scooter bike!

- Ensure the scooter bike is in good condition each time before using it. Check before **each** ride that the brakes are in order. Check the lighting and make sure there is enough tyre pressure (recommended: 3 bar).
- Always get a punctured tyre repaired before using the scooter bike. To avoid damage to the wheels or other parts.
- Regularly check if the wheels, the handlebars and the seat are properly fixed and also that all the screw connections are tight enough.
- Only use the scooter bike on a **solid and flat surface**. Soft, slippery or uneven terrain increases the risk of dangerous situations.
- Make sure that wide trousers or loose hanging clothing don't get caught in the chain, spokes or pedals.
- Take care that fingers and limbs do not get trapped while folding up or down the footrest and armrests.
- Be aware of the protruding parts on the scooter bike. These could cause damage to the surroundings and the scooter bike.
- Do not use a pressure washer or a steam cleaner for the cleaning of the scooter bike.
- Use the parking brake when you park (and leave) the scooter bike. Use the parking brake, even while getting on or off the bike to prevent its accidental movement.
- Always switch off and lock the scooter bike when leaving it unattended. This prevents the unwanted use and / or theft.
- This scooter bike is suitable for transporting a single person.
- Only use original Van Raam parts and accessories.
- Ride carefully on roads that are slippery due to rain, ice or snow.
- Watch out for overturning when riding up a slope. The scooter bike is equipped with ascent limiters to limit the risk of overturning.



- Avoid slopes steeper than 6°. Riding this scooter bike (forward or in reverse) on steep slopes can be dangerous.
 - Please note that the stopping distance could be greater on a slope as compared to a horizontal surface.
 - Make sure that you do not reach a dangerous speed when driving downhill and entering tunnels. Brake in time and bike at a moderate speed.
 - Ride carefully along (pavement) edges. An uneven surface increases the risk of overturning.
 - Turn around carefully on a steep slope to avoid the risk of overturning.
 - Always get on and off a pavement in a forward straight line, using a curb cut. Do this at an appropriate speed.
 - Always drive perpendicularly and at low speed off the curb or speed bump.
 - The maximum bump height that you can get on and off is 5 cm.
 - In case of pregnancy, extra care is required owing to a higher risk of injury.
 - Do not leave the scooter bike in direct sunlight: the temperature of some parts could exceed 41°C resulting in possible burns to the skin.
 - When transporting the scooter bike in a motor vehicle, always make sure you are seated in a fixed seat of the motor vehicle. Scooter bikes may never be used as seating support in a motor vehicle, not even when the scooter bike is secured with a taxi restraint system.
 - Never lift the scooter bike holding the batteries or the plastic parts at the back.
 - Practise the reversing and acceleration functions of the electric motor. Always pay attention when you turn on the electric motor and do not be surprised by the sudden behaviour of the electric motor.
- Please be careful** not to switch on the reverse function of the electric motor inadvertently.

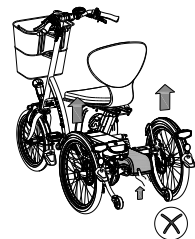
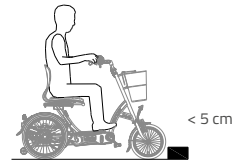
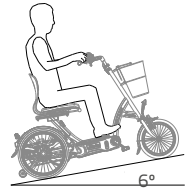

Road safety

- If you are under the influence of medicines that may affect your ability to drive, you are not allowed to drive a scooter bike.
- Your vision must be adequate to drive the scooter bike safely in any situation that may occur during use.
- Please follow the relevant traffic rules that apply.
- Make sure that you are always noticed by the other road users. As a user of a scooter bike you are very vulnerable in traffic.
- Switch off the electrical system if you are using your mobile phone.
- You need to be at least 16 years of age to ride a scooter bike.
- Only enter the sidewalk or a pedestrian area in the scooter mode when the engine is active at level 1.

Load

The maximum load should not be exceeded. See the information in the technical data table under the heading **‘Technical specifications’** of the user manual. By permitted load we mean the total load, including the load in the basket or on the luggage rack.

Make sure that the permitted basket weight is not exceeded (**maximum 20 kg**). You may not carry passengers in the basket and you may not place luggage anywhere else on the bike. Do not allow anyone to stand on the rear side of your scooter bike.

Note that a basket full of luggage can considerably influence the driving. No luggage may be carried on the handlebars of the bike, as it limits the manoeuvrability of the scooter bike.

Damaged or worn out parts

The replacement and repair of parts (frame, forks, light, brakes, drive mechanism and the handlebars) should **always** be performed by an authorised dealer. If not, the guarantee ceases to be valid and you will be personally responsible in the event of possible damage.



Specific safety parts should **always** be replaced by new parts!

Adjustments of the bike

Before using the scooter bike, adjust it to the measurements of the driver. This is of great importance, especially the seat and the handlebars.



If an optimal adjustment of the scooter bike, as defined in the instructions, is not possible, you can contact your dealer for a fitting solution.

The brakes are correctly adjusted and should only be adjusted by the dealer during periodic maintenance.



Take care that fingers and limbs do not get trapped while adjusting the scooter bike.

Seat

When the cyclist is sitting on the scooter bike and can put a foot on the pedal in the lowest position, the seat height is correct. Adjust the seat height in such a way that the leg is stretched but relaxed in that position.

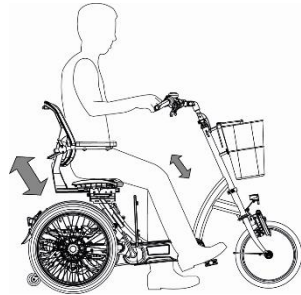

Seat height

To adjust the height:

1. Loosen the two clamping levers.
2. Move the seat to the desired height and tighten the clamping levers.
3. Pull out the clamping lever and set it in such a position that it does not protrude.



Make sure clothing cannot get caught in the clamping levers!



Ensure that the clamping levers are always firmly tightened, even with the seat in the lowermost position!

Seat depth

The seating area of the seat can be adjusted to tailor the seat to the user's comfort. In order to adjust the seat, follow these steps:

1. Remove the seat cushion [A] from the seat frame.
2. Now that the seat cushion has been removed, the seat frame can be adjusted in relation to the backrest. To do this, loosen the 4 socket head screws [B] a few turns.
3. Slide the seat frame forwards or backwards.
4. Tighten the 4 socket-head screws [B].
5. Place the seat cushion by first sliding the front edge over the seat frame. Then push the 4 snap covers into the holes.

Caution! Adjusting the seat depth affects the minimum and maximum inside leg length for the bike.

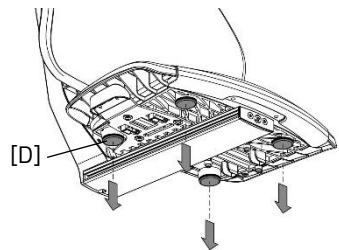
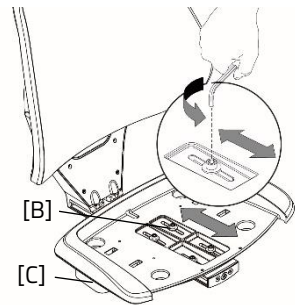
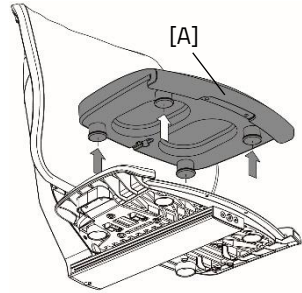

Handlebars height

The height of the handlebars affects the comfort of the ride. It determines the pressure on the hands and the position of the back. You decide the most comfortable position yourself with some practice.

To adjust the handlebars:

1. Slightly loosen the screw by using an Allen key.
2. Move the handlebars to the correct height and tighten the screw very firmly again.

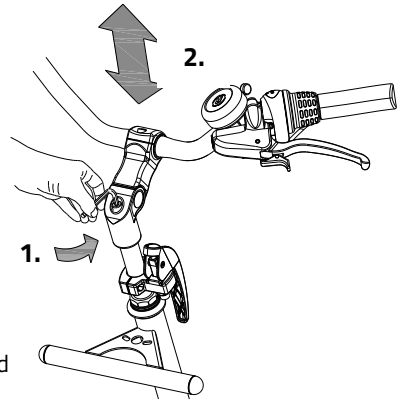

Do **not** pull out the handlebars **further** than the mark. Otherwise the tube will not be deep enough in the shaft and will risk coming off, which can lead to serious injuries.



Position handlebars

You can tilt the handlebars. This influences the distance from the handlebars to the upper body. Determine your own most comfortable position by using the bike.

To tilt the handlebars:

1. Slightly loosen the screws [A] and [B] with an Allen key.
2. Put the handlebars in the desired position and then tighten the screws considerably.
3. Slightly loosen screw [C] with an Allen key, put the handlebars in the correct (horizontal) position and then tighten the screw again.

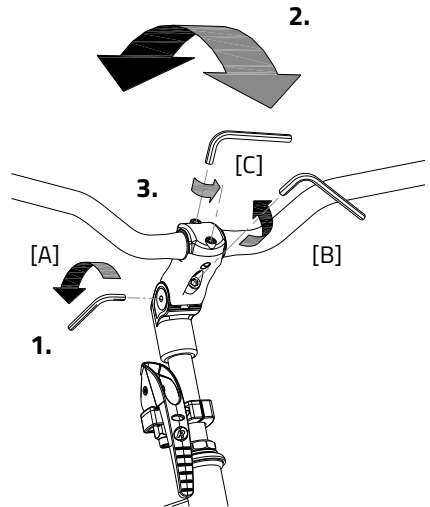

Before first use

Parking brake

Always use the parking brake if you park the tricycle and leave it behind.

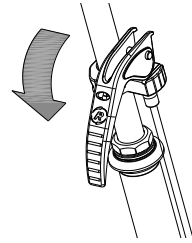

Block the tricycle with the hydro brake when passengers are getting on and off.

To operate the parking brake, squeeze the left brake [A] and secure the brake with the lever [B].

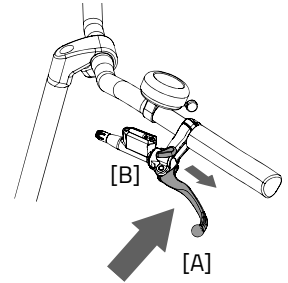

Always try to park the tricycle on a level surface. The tricycle may never be parked on a slope bigger than 6 degrees.

Handle basket

The scooter bike is equipped with a handle basket. Hang the basket at the handle's bracket.



Ensure that the permissible basket weight is not exceeded (**maximum 20 kg**). Note that a basket full of luggage can considerably influence the driving.

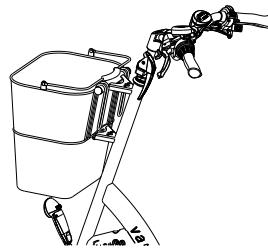
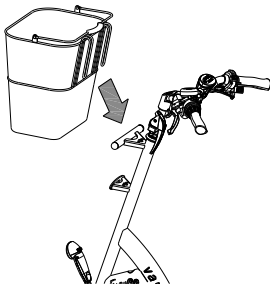

Centrally Operated Lighting

The bike has been equipped with centrally operated lighting, with the lighting being connected to the electric system.

The lighting will turn on automatically when the electric system is activated.

Adjust the angle of the headlight, so that the centre of the light beam is aimed about ten metres in front of the bike.

You can manually turn the lighting on and off by briefly pushing the on/off button on the display. When the electric system is turned off, the lighting will turn off automatically.

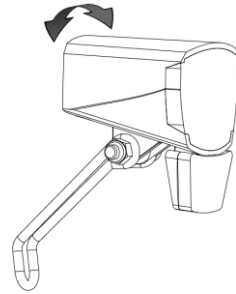

Make sure there is always a battery on the bike when you are cycling after dark!

Once the battery is nearly empty, the motor will no longer provide pedal support power assistance while cycling. The lighting will still be powered by leftover power.

Gears

The scooter bike has eight gears. The gear is operated by turning the grip.

Do not use the pedals when turning the grip.

Check before every ride:

- The brakes (including the parking brake)
- The tyre pressure (recommended: 3 bar)
- The lights
- That all the parts are fitted properly
- That the battery is adequately charged

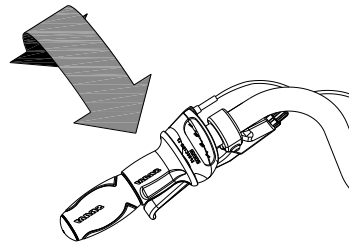

Contact your dealer and stop using your scooter bike as soon as you observe irregularities during the check!

As with all mechanical parts, the scooter bike is subject to wear and tear and high loading. If a component fails, it can lead to very dangerous situations. This can lead to damage or injuries to the user of the scooter bike. Any form of cracks, scratches or change in colour in load heavily loaded parts of a component indicates that the component must be replaced.

Points to remember while cycling

You can use the scooter bike once you have adjusted the scooter bike according to the measurements of the driver.



The tricycle gives a very different ride experience than a bicycle.

Practice, in particular, with bends and braking, because a tricycle may react contrary to your expectations. It may happen that the back wheel comes off the ground on the inside when going round a sharp bend. To avoid this the rider leans towards the inside of the bend with his body.

One of the brake levers (usually the right) operates the brake on the front wheel. This deserves special caution, as a forceful braking could block the front wheel, which could result in a fall. The driver should be familiar with controlled braking of the front wheel!



As the scooter bike is equipped with an electric motor: make sure that you practise with the acceleration and reversing functions. Be careful that the acceleration mode or reverse mode are not unintentionally started while using the scooter bike. For example: If you wait for the traffic light and you play with the pedals by moving them backwards the reverse function is activated and the scooter bike goes backwards.



High speeds in corners, on uneven terrain and extreme steering angles could lead to the **overturning** of the tricycle!



Extra attention is needed when a child or an adult with limited powers of perception uses the scooter bike! (The minimum age for riding the Scooter bike in traffic is 16 years.)

Before a child or an adult with limited powers of perception rides the scooter bike independently for the first time, they should practice first under your supervision (or under the supervision of others).

Pay special attention to the turning because it could lead to dangerous situations. Also explain to the driver that the widest part of the scooter bike lies behind him / her. Let him/her practise by riding over a few obstacles to get an idea of how wide the scooter bike is!

Children or adults with limited powers of perception should **always** be reminded about the possible dangers/ risks involved in using the scooter bike.

Important safety points for the rider

- Be very careful during the first ride.
- When riding the scooter bike hold both hands firmly on the handlebars and feet on the pedals or the feet plate.
- Test the riding style of the scooterbike on rough ground at moderate speed. This way the cyclist learns how to react to unexpected movements of the scooterbike and the handlebars during use.
- Explore how the tilting movements of the scooter bike react to body posture. Tilt to the inside of the bend.
- Small obstacles should be cycled over with appropriate speed.
- Obstacles higher than five centimetre should be avoided.
- Ensure that no dangerous speed develops while driving downhill and entering tunnels. Brake on time and cycle at a moderate speed.

Operation

The scooter bike can be used in two different ways, as a cycle and as a scooter. These two modes can be interchanged simply by folding the footplate (with the hand or foot). When you have folded down the footplate, the bike works as a scooter and when you fold it up, you can pedal along. In the cycling mode, you can even use the throttle as an extra support, if required.

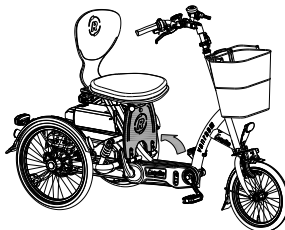
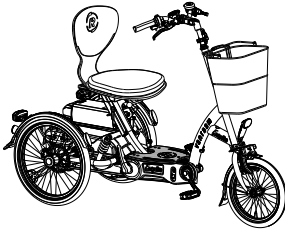

1. Scooter mode:

- Footplate down.
- Ride forward and backward with the thumb throttle.
- Pedals are disengaged.

2. Cycling mode:

- Footplate up.
- Driving activated by pedaling.
- Power assistance depending upon pedaling power and speed.
- Extra assistance with the help of the thumb throttle.
- Reverse riding by reverse pedaling.



When getting on, first take your place on the seat, and then you can lift your legs safely across the frame or the footplate. This way you can avoid being stuck or slipping on the footplate, which can be slippery when it is wet.

Brakes

The handbrakes should be used for coming to a standstill, in the cycle mode as well as the scooter mode. The parking brake should be used to avoid the scooter from rolling away on its own when left unattended.

Silent electrical system

The Silent electrical system comprises 5 components: display, button unit, battery, motor and bottom bracket. How the first 3 parts are used is explained in this user manual.

Operation of the display

The display provides you with cycling information, which will be explained in more detail later. The display is mounted onto the handlebars by means of a bracket. The display cannot and does not have to be removed when leaving the bike.

(1) On/off

This button switches the electrical system on.

(2) Bicycle lights

The lights on the bicycle switch on automatically when the electrical system is switched on. By pressing this button briefly, the lights can be switched off (and on).

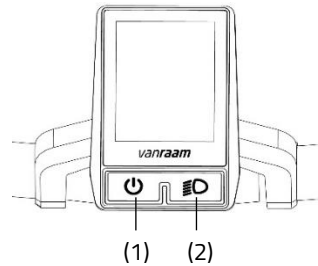

Operation of the button unit

The button unit is mounted next to the handlebar grip. You use the button unit to operate the electrical system.



The button unit can be mounted on the other side of the handlebars by your dealer.

(3) Mode

By pressing this button briefly, you can switch between the different Screen modes.

(4) Plus - Increase pedal support power assistance

(5) Minus - Reduce pedal support power assistance

(6) starting aid

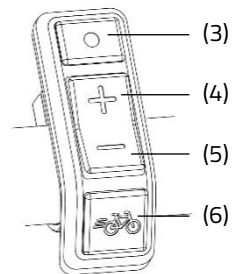

Information screen

After the electrical system is powered up, the information screen is displayed. This screen displays real-time cycling information.



The information screen will only work if you have switched on the electrical system.

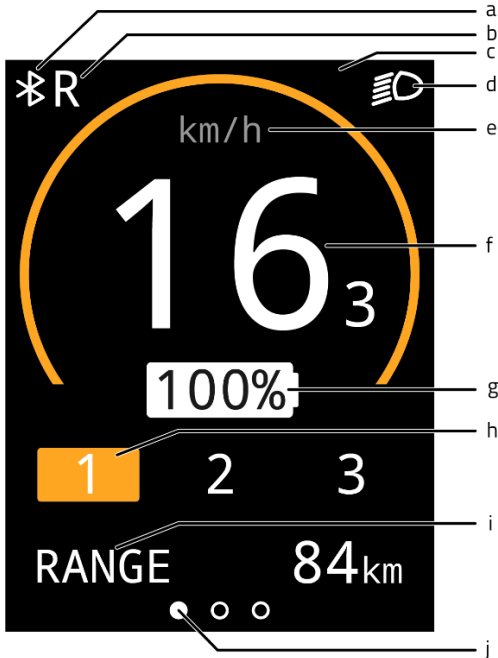

- (a) Bluetooth connection
- (b) Reverse function of (thumb) throttle activated
- (c) Notification field
- (d) Bicycle lights
- (e) Speed indicator
- (f) Speed
- (g) Battery charge percentage
- (h) Assistance mode
- (i) Screen modes
- (j) Screen mode orientation bar

Screen modes

The screen mode (i) can be set by using the mode button (3) You can switch between the following 3 screen modes while cycling.

1. Radius of action [RANGE] (default display)
This is the number of kilometres that can still be cycled with the remaining battery capacity in the active assistance mode.



The range is assistance mode dependent and is an estimate, so the actual range may differ from the estimate. The range is dependent on several factors. Among others, the range is influenced by: battery capacity, amount of assistance, tyre pressure, ride speed, rider weight and load, and the environment.

2. Trip distance [TRIP]
This is the distance travelled since the trip odometer was last reset. By holding down the mode button for one second, the trip odometer can be reset to 0. The trip odometer must be visible on the mode screen for this.



3. Total distance [TOTAL]
This is the total distance travelled by the bicycle when the electrical system has been switched on.



Settings screen





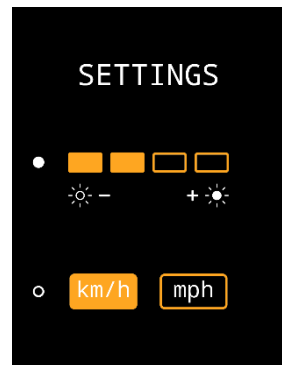

In the settings screen, the brightness of the display and the units of distance and speed can be changed.

To access the settings screen, the mode button (3) and the plus button (4) should be pressed down simultaneously for one second. Using the mode button (3), you can switch between the settings. The plus and minus buttons (4,5) are used to adjust the setting. To exit the setting screen, press and hold the mode button (3) for one second.



Notifications

Several symbols can be displayed in the information screen. The symbols are explained below. More information on the notifications can be found in the chapter **“Possible Faults”**.

-  The bicycle lights are activated
-  A Bluetooth connection is active
-  No communications with the battery
-  Reverse function of (thumb) throttle is activated
-  The temperature of the controller is too high
-  Voltage is too high
-  Fault

Pedal support power assistance

The Silent electrical system provides assistance while cycling.

Fully electric driving

In the mobility scooter mode, the electric motor is controlled using the thumb throttle. By using settings 1, 2 and 3, you can set a different value for the maximum speed.

With the forward/reverse switch, you determine the direction of travel.

- 0 = forward
- = reverse

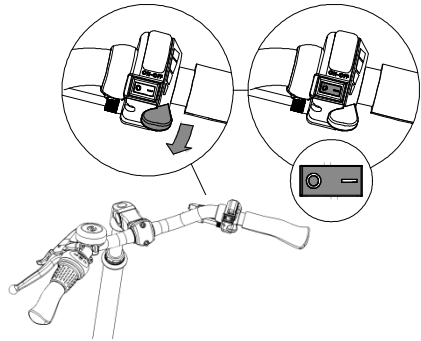

In the reverse mode, there is no option to select the maximum speed; the lights for settings 1, 2 and 3 all illuminate to indicate that the reverse mode is activated.



Do not use settings 2 or 3 on the sidewalk or in a pedestrian area.



When you activate the electrical system, all green lights will illuminate for 2 seconds. Wait for these 2 seconds before using the thumb throttle until only the light for setting 1 remains illuminated.

Assistance settings

The pedal assistance level can be set using assistance settings 1, 2 and 3. The assistance settings can be changed while cycling.

1. Low level of assistance, maximum range.

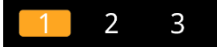

2. Average support, average range.



3. Maximum support, low range.



Reverse pedalling

The reverse function is activated by pedalling backwards from a stationary position. After a few turns of the wheel, the motor is activated and the bicycle will reverse at the speed of 3 km/h for as long as it is pedalled backwards.



Do not let the electric motor's sudden behaviour take you by surprise. For example, if you wait at the traffic lights and pedal backwards just for fun, the reverse function will be activated and the bike will start riding backwards!

Presets

A preset is a set of settings which sets the level of assistance. By loading a different preset, the level of assistance for all assistance settings can be adjusted. Presets can be changed by the dealer or through the Van Raam app.

Van Raam E-Bike app

With the app, you can track various information and configure the assistance modes. (More information on this can be found in the chapter on the Van Raam E-Bike app)

Charging the battery

To charge the battery:

1. Unlock the battery by turning the key a quarter turn.
2. Press the lock in and simultaneously pull the battery pack out of the holder with your other hand.
3. Take the battery with you inside. **First** plug the charger into the power outlet. The green LED will light up. The charger is now on stand-by.
4. **Then** plug the charging connector of the charger into the charging point of the battery. The red LED will light up. The charger is now charging.



Caution! If the battery is not properly connected, then the green LED will be on (standby mode). In case of an unsatisfactory connection, unplug the charger from the power outlet and clean its connector with a dry cloth.

5. The charging time depends on the battery status. The charging time is approximately 2 hours for a 11.4 Ah/36 V battery and approximately 4.5 hours for a 23,5 Ah/36 V battery.
6. As soon as the battery is fully charged, the green LED will light up continuously. Now **first** remove the charging connector from the battery.
7. **Then** remove the charger's plug from the power outlet.
8. Place the battery back into the holder on the bicycle and lock the battery. Optionally, the battery can also be charged directly in the holder.

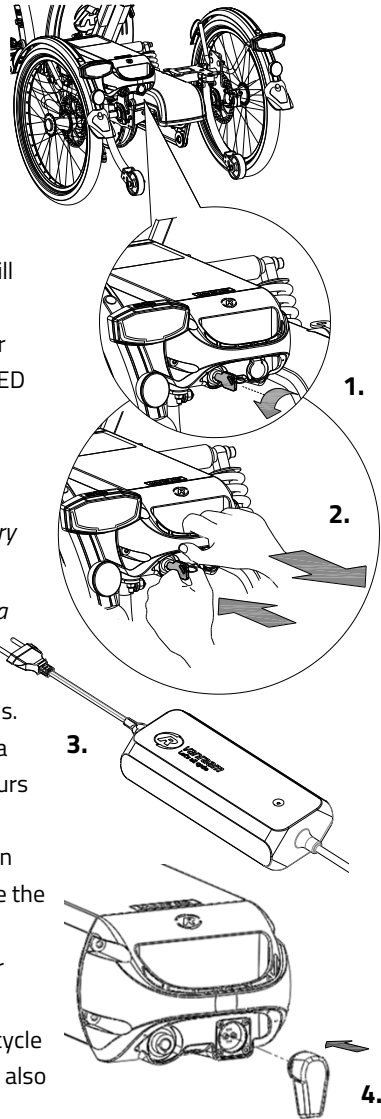

Charger indicator light

The status of the charger is indicated by the colored indicator light.

- If the indicator light is green, the charger is in standby mode or the battery is full.
- If the indicator light is red then the charger is charging the battery.
- ⊘ If the indicator light flashes red then the charger is in safety mode.

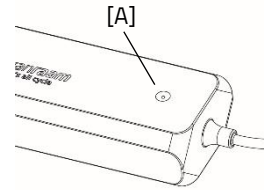

Caution! Unplug the charger from the power outlet.



Only use the charger when the ambient temperature is between 0 and 35 C.



It is better for the battery to be charged periodically instead of waiting until it is completely empty.

Battery indicator lights

On the battery pack there is an LED indicator to check the battery charge status. The battery charge status can be read by briefly pressing the on/off button [A]. While the battery is being charged, the indicator shows the charging progress:

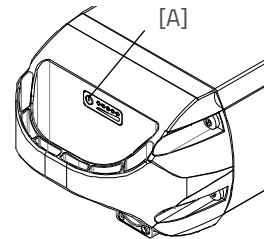

The battery is fully charged. When the battery is used, the number of green lamps will decrease.



If two green lamps are lit, the battery is 50% charged.



If only the left LED remains green, the battery is almost empty and needs to be recharged or replaced with a charged battery.



If the left LED starts blinking green, the battery is empty and the motor will not support cycling for much longer. However, the switchable lighting will still work after that.



Never put the bike away with an empty battery.

Deep sleep battery mode

When the battery is almost empty and has not been used for a week, the battery will go into a "deep sleep mode". In this mode, the battery uses as little energy as possible, which extends the battery life.

When "deep sleep mode" is activated, the battery cannot be used. By pressing the on/off button [A] on the battery, the battery will be released from 'deep sleep mode' and can be used again. It is advisable to charge the battery before using it.

Charging and maintenance of the battery pack

Important safety warning:

- To ensure the battery's optimal condition and capacity, we recommend charging it indoors at room temperature.
- Never put the bicycle away with an empty battery. We recommend charging the battery as soon as possible when it is empty. The best storage charging level for the battery is when the charge display shows three to five LED lights.
- In winter, check the battery charge every other month, recharge it if less than three LEDs light up.
- Preferably store and use the battery between 5 and 20 C, avoid higher and lower temperatures.
- Do not charge the battery in direct sunlight and make sure that the battery is not charged at a temperature lower than 5 C.
- Only use the charger in dry indoor areas, the charger is not allowed to get wet.
- Only use the supplied Van Raam battery and charger.
- The housing of the battery and the charger must not be opened. In case of any problems, please consult your dealer.
- A Van Raam battery is not allowed nor is it possible to recondition the battery due to safety reasons and incorrect functioning of the electrical system.
- Do not drop the battery as this can cause external and internal damage.
- If the bicycle malfunctions, the battery must be disconnected from the bicycle.



Keep in mind that the bike provides less assistance at lower temperatures (0°C and below) and that the battery will drain more quickly. It also takes longer to charge at low temperatures.



Every battery drains over time. This process is called 'self-discharge'. A battery that is empty and not charged can undergo a deep discharge caused by self-discharge and become faulty as a result. The warranty is voided in the case of a deep discharge.



Keep in mind that every battery wears out over time. The wear and tear process of the battery is inevitable and depends on several factors such as use, the number of times to fully discharged and charged and the ambient temperature. Even if the battery is not used, its capacity will decrease. A worn-out battery can be used, but keep in mind that the range will be reduced.

Possible faults

- The system cannot be switched on:
 1. Check that the battery is attached properly.
 2. Check the status of the battery. If it is empty, charge the battery.
 3. If the above does not provide a solution, please contact your dealer.
- If a red LED flashes on the charger, unplug the charger from the power outlet and stop using the charger and battery. In this case, contact your dealer.

Faults table

Fault symbol/ code	Description	Consequence/ course of action
All assistance modes are flashing	Temperature controller too high	System does provide assistance, motor power is reduced.
Thermometer (symbol) + all assistance modes are flashing.	Temperature controller too high	System does not provide assistance, let the controller cool down.
Battery with cross (symbol) + all assistance modes are flashing	No communications with the battery	System does provide assistance. Contact your dealer.
Lightning bolt (symbol) + assistance settings are turned off	Voltage too high	System does not provide assistance, voltage drops automatically when cycling speed is slower than maximum assistance speed.

Exclamation mark (symbol) Exclamation mark (symbol)	Voltage too low	System does not provide assistance, check the connection between controller and battery. Check how full the battery is.
	Controller communication error	System does not provide assistance. Contact your dealer.
Active assistance mode is flashing	Electrical current too high	System does not provide assistance. Contact your dealer.
Active assistance mode is flashing	Motor sensor fault	System does provide assistance. Contact your dealer.
All assistance settings are turned off.	The battery is almost empty.	Charge the battery

Charging and maintenance of the battery pack

Important safety warning:

Charger safety precautions

- Only charge Van Raam Li-Ion batteries with the supplied charger. Only connect the charger to a suitable wall socket (220–240 Volt AC 50–60 Hz). When the charger is not in use, disconnect it from the power outlet and the power plug from the battery.
- The charger may only be used by persons who have read the information in this manual and are familiar with the correct use of the charger. Keep the charger out of reach of children; they should not play with the charger.
- The charger is designed for use in a dust-free, dry and ventilated environment. Do not expose the battery to water, heat sources and direct sunlight. Keep the charger clean and dry.
- Do not charge batteries that feel hot. The battery may only be charged in places where the temperature is no higher than room temperature. Stop charging if the battery gets hotter than ($> 40^{\circ} \text{C}$).

Caution! The charger can become warm during charging $> 50^{\circ} \text{C}$. First, carefully feel whether you can pick up the charger, this temperature can cause hypersensitivity or a startled reaction when it comes into contact with the skin.

- Do not use the charger if it is visibly damaged or modified. Do not repair the charger yourself! Please contact Van Raam. You are strictly prohibited from opening the charger yourself!

- Always keep an eye on the charger and battery while charging. When the battery is full, disconnect the power plug from power outlet and remove the power plug from the battery.

Silent Electrical System options

There are different options for the electrical system for each bicycle model.

External charging point

In order to make battery charging more accessible, the bicycle can be equipped with an external charging point in the backrest. The battery does not have to be removed from the bicycle to be charged. The external charging point is placed on the seat closest to the battery.



If it fails to charge, check whether the power plug of the external charging point is properly connected to the battery.

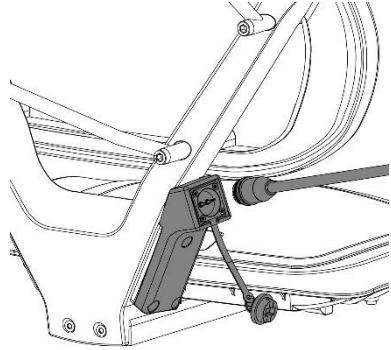

Spare battery

The bicycle can be equipped with a second battery. The second battery can be used when the first battery is empty. The batteries will need to be swapped.

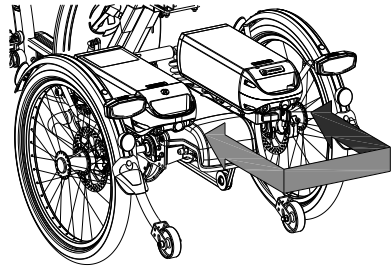

Switchable battery pack

If you have two batteries, the bicycle can be equipped with the switchable battery pack option. Once the connected battery pack is empty, you can switch the system to the second battery pack by using the switch. This is located between the seats.

Direction indicator

The scooter bike can be equipped with a turn signal set. To operate the turn signals, press the switch [A] on the handlebar to the left or right. When the turn signal is active, a clicking sound can be heard. To deactivate the turn signal, you must set the button to the middle position. The turn signal set is powered by the battery of the Silent Electric System.

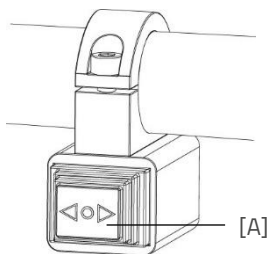

Note! The turn signals only work when the lights are turned on.

Van Raam e-bike app

The Van Raam bicycle app is a free smartphone app that you can use while cycling on your electric Van Raam bicycle.

What can you do with the Van Raam e-bike app?

- App can be used as a luxury bicycle computer
- Change bike settings
- Send SOS messages with GPS location to a number of your choice
- View information about the bike

How does the Van Raam e-bike app work?

With the Van Raam e-bike app, a connection can be made with the display via Bluetooth connection. As soon as the display is ready to connect to the smartphone, the on/off button will briefly turn blue.

This app can be used as a luxury bicycle computer for Van Raam bicycles with pedal assistance and also contains many other extra functionalities. The dashboard on the app shows the current speed, total distance, trip meter, battery capacity and power consumption during the bike ride. For more cycling data, there is a details screen including average speed, maximum speed, total distance, power, battery voltage, pedaling power and pedaling frequency.

The Van Raam e-bike app can be downloaded free of charge from the **Google Play Store** or **Apple App Store**.

For more information about the Van Raam e-bike app, you can visit the Van Raam website: www.vanraam.com.



Accessories

Depending on your order, you can use the accessories as described below.

Armrests (optional)

Item number: -0060/-7056

The armrests give the user extra comfort and safety.

To make it easier to get on the bicycle, you can fold up the armrests separately from each other.

While cycling, you can rest your arms on the armrests. Do **not** use the armrests as support when getting on and off.



Caution! The armrests must not be subjected to loads exceeding 50 kg.

Hipbelt

Item number: -6020/-6021

Wrap the hipbelt around their body and click the buckle into the lock.

Caution! When retracting the hipbelt, be sure to feed it back in a straight direction to prevent it from getting stuck.

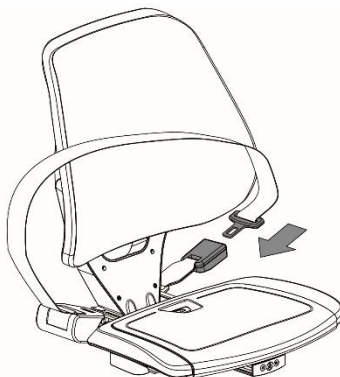

Crank shortener

The crank shortener is fitted to the crank, as illustrated. The pedal can then be fitted into the crank shortener at two positions.

With the Allen screw [A] the crank shortener should be aligned with the crank.

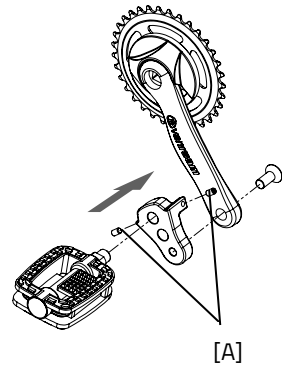

Walking-stick holder

The walking-stick holder is attached to the seat. The stick(s) should be secured with the Velcro.

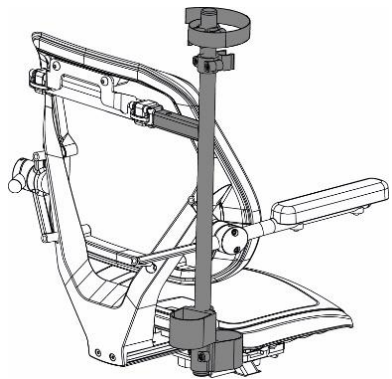

Technical specifications

Length (cm)	166
Width (cm)	72
Frame height (cm)	115
Boarding height (cm)	29
Front wheel	16"
Back wheel	20"
Type of tyres	Pneumatic tyres
Weight (kg)	approx. 64
Brakes, front	Hand brake
Brakes, back	Hand brake
Battery	Li-ion 36V
Max. static stability downhill	10°
Max. static stability uphill	10°
Max. static stability on a lateral slope	10°
Max. dynamic stability uphill	6°
Max. safe gradient	6°
Max. obstacle height (cm)	5
Max. obstacle to be driven on to (sidewalk) (cm)	5
Max. loading of luggage basket / carrier (kg)	20
Max. user weight (kg)	120

Max. permissible load (kg) combination user and luggage	140
Max. speed with fully electric system (km/h)	15
Turning radius (cm)	180
Action radius* (km)	35
The Easy Go is normally delivered with three levels for the speed; 5 km/h, 10 km/h and 15 km/h	
Gas operation using thumb throttle, or electric assistance while pedaling.	

* With the standard battery (11.2 Ah), fully electrical operation with normal use.

Beware! The action radius depends on a lot of different factors and is strongly influenced by: capacity and voltage of the battery, degree of support that is used, temperature, wind speed, tyre pressure, cycling speed, weight of the user and the luggage, use of gearing etcetera.

Standardisation and CE-marking

The scooter bike complies with the provisions specified in the directive for Medical Devices and is provided with a CE-marking.

Maintenance and adjustments by owner

Below you can find the instructions for maintenance and adjustments that you can do yourself on a regular basis, which will keep your scooter bike in top condition.

Cleaning

The frame of the scooter bike can be cleaned with a damp cloth. For areas that are dirtier you can use a mild detergent.

The wheels can be cleaned with a moist brush with plastic hairs (not a wire brush!).

The grips, seats and upholstery of the seat and back can be cleaned with a damp cloth and mild detergent.



Do not use a pressure washer or a steam cleaner!

The right lubricant

The chain should be cleaned and maintained at regular intervals (every three months approximately). Only use special chain grease or Teflon spray. This is the only way to make sure that the chain will run smoothly, will stay water resistant and will not rust.

1. Wipe the chain with a cloth.
2. Treat it with grease or spray.
3. Remove any excess lubricant with a rag.

Other parts should **not** be treated with a lubricant.

Inspection of the scooter bike

It is recommended that the scooter bike has a yearly inspection carried out by the dealer to claim warranty. Please use the form "Form service, maintenance, modifications and warranty claims" in the back of this manual. After 200 kilometres or after a period of two months the scooter bike should be inspected.

In the event of technical trouble or faults, the scooter bike should be taken to the dealer for repairs **immediately**.

The replacing of safety-related components (especially frame, brakes, lighting, handlebars, front fork and actuation) should be performed by the dealer.

If you still decide you want to replace components yourself, you are responsible for damage or harm due to incorrectly fitted components.

Only use **original** Van Raam spare parts, which you can buy at you dealer. If requested the dealer will make the necessary information on repair and maintenance available.

Repairs and maintenance to be done by dealer

Check the brakes, the rims, lighting, the chain tension and the spokes. Also check the tyre tread depth. This should be at least one millimetre. Worn out tyres or possible faulty parts should be replaced. Also check the parking brake. With the parking brake pulled up, the scooter bike should not ride away with the cyclist.

Checking the rim

Due to the combined action of the brake and the rims, not only the brake lining but also the condition of the rim is important. For this reason the rim should be checked at regular intervals, for example when you inflate the tyres. The presence of fine cracks in the spoke punches or deformation of the rim when there is higher air pressure, indicate more serious wear and tear. In that case the rim should be replaced, because it can lead to loss of brake function or even a crack in the rim, which can lead to all kinds of dangerous consequences.

Repairs, maintenance and modifications should only be performed with original Van Raam parts.

Adjustments to be done by dealer

The correct tension of the chain

Several chains are present on the scooter bike. The chains should not be too tight. Without efforts you should be able to move the chain up and down, about half a centimetre.

Adjusting the chain tension of the foremost chain

To keep the foremost chain of the scooter bike tight, secure the chain tension wheel. To do this, follow the instructions given below:

1. Loosen the cap nut a few turns with a socket spanner.
2. Move the chain tension wheel, so that the chain is under light tension, as described above.
3. Tighten the cap nut again.

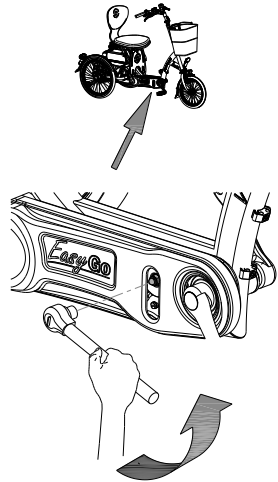

Adjusting the chain tension of the hub chain

In order to tighten the hub chain, the hub is adjusted. To do this, follow the instructions given below:

1. Loosen the nuts of the hub with a socket spanner a few turns, so that the hub can move back and forth.
2. Tighten the nuts on the two chain tensioners, so that the hub slides back and the chain is tightened. Tighten the chain till the tension described above is reached. (Remember to tighten both the nuts equally.)

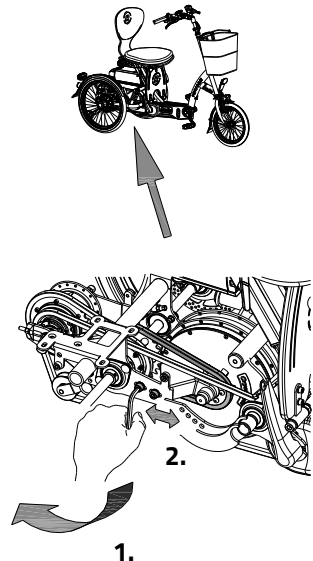

3. Tighten the nuts of the hub slightly.
4. Check if the chain tension is correct.
5. Tighten the nuts firmly.

Adjusting the chain tension of engine chain

In order to maintain the correct chain tension of the engine, the engine is adjusted. To do this, follow the instructions given below:

1. Loosen the socket screws of the engine bracket with an Allen key a few times, so that the engine can move back and forth.
2. Tighten the nuts on the two chain tensioners so that the engine slides forward and the chain is tightened. (Remember to tighten both the nuts equally.)
3. Tighten the socket screws of the engine bracket slightly.
4. Check if the chain tension is correct.
5. Tighten the nuts firmly.

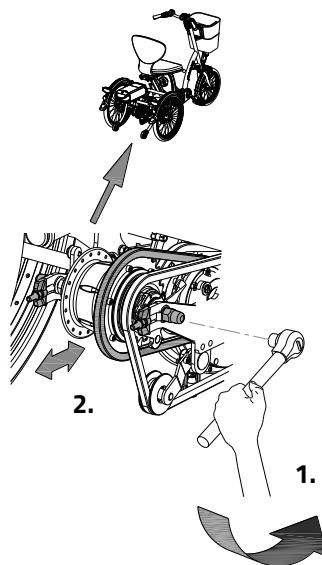

Adjusting the suspension

The suspension is set at the factory. There are four positions possible. The suspension can be set as lighter or heavier by assembling the socket screws in different positions.

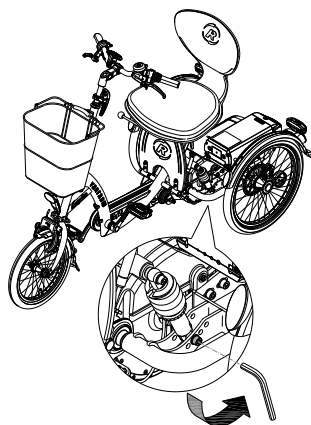

Caution: This handling should **always** be done by a dealer.

Disposal

If you want to dispose your tricycle, contact your dealer. You can also contact the local waste disposal company. They will dispose the tricycle according to the regulations of your town.

Recycling the Battery

If your battery is defective or if you are no longer using it, you must have it recycled. Please contact your dealer. They are responsible for complying with the recycling obligation. Ask them about the conditions or view the rules regarding recycling in your place of residence/country.

Handover/sale to a new owner

When you hand over your scooter bike to a new owner it is important that you also hand over all necessary technical documentation and spare keys, so that the new owner can use the scooter bike safely.

Guarantee

The guarantee is valid for all faults in the product, which are proven to be caused by material or manufacturing error.

We give a guarantee of five years on the frame and the front fork. For all accessories and other parts (except wear parts) we provide a two year guarantee, as legally regulated. The guarantee only applies for normal use and maintenance of the scooter bike, as described in this manual.

Beware!

The guarantee as well as the product liability in general expires if the instructions stated in this manual are not followed. This is also the case if unauthorized maintenance is carried out or if technical changes or additions are made with non-original Van Raam parts without permission of Van Raam. The original CE certification will become nul-and-void if

modifications are done by third parties. The absence of the certification can lead to problems in insuring your bike, and for any loss or incurred.

Frame number

The frame number is printed on the sticker. This sticker is located on the frame, see illustration.

Example of sticker:

Fabrikant/ Hersteller/ Manufacturer	Van Raam	Voor gebruik handleiding lezen
Voertuigtype/ Fahrzeugtyp/ Vehicle type	Easy Go	Vor Gebrauch Anleitung lesen
Bouwjaar/ Baujahr/ Year of production	2016	Read instruction manual before use
Voertuigidentificatienummer/ Fahrzeug-Identifizierungsnummer/ Vehicle identification number	XXXXX	Van Raam BV Aaltenseweg 56 7051 CM Varsseveld The Netherlands T +31 (0)315 257370 www.vanraam.com
Maximaal toelaatbaar totaalgewicht/ Zulassiges Gesamtgewicht/ Admissible total weight	224 kg	
Toelaatbare aslasten/ Zulässige Achslasten/ Permissible axle loads	44 kg as 1/ Achse 1/ axle 1 180 kg as 2/ Achse 2/ axle 2	CE

Position of sticker:



Maintenance recommendation

A Van Raam bike often is subject to extensive use and must perform in all weather conditions. By correctly maintaining the bike, the lifecycle can be extended greatly. This maintenance can be done by a Van Raam dealer. In most cases, you can do the monthly and annual inspection yourself.

Maintenance Overview:

What	One-person bike	Multi-person bike	Duration	By whom?
1 st service moment	3 months/300 km	3 months/200 km	15 min	Dealer
2 nd Service moment	6 months/1.000 km	6 months/500 km	15-30 min	Dealer
3 rd Service moment	12 months/2.000 km	12 months/1.000 km	30-90 min	Dealer
Monthly inspection*	Every month	Every month	15 min	User
Annual inspection*	Every 12 months	Every 12 months	60 min	User

* This is advised to extend your bike's lifecycle. You can also have this done by your dealer.

Monthly inspection

15 minutes

Among them:

- Check and inflate the tyres
- Check the chain tension and grease if needed
- Tighten bolts/nuts where needed
- Check all lights
- Check the brakes
- Check all rotating parts and grease if needed
- Clean the bike

Annual inspection

60 minutes

Among them:

- Check and touch up the paintwork
- Check the wheels for any buckling
- Check the spoke tension
- Check the steering ball joints
- Check all lights
- Check the saddle clamp
- Check the placement of all electric components (E-Bikes only)

1st Service moment

15-30 minutes

Among them:

- Check tyres and inflate
- Check the spoke tension
- Check the chain tension and grease
- Tighten any bolts and nuts if needed
- Check all brake cables and brake calipers
- Check the gears
- Check and grease all rotating parts
- Check all lights
- Clean the bike

2nd Service moment

30-90 minutes

Among them: All points from service moment 1, and:

- Inspection of the pedals and bottom bracket
- Grease and tighten the lock
- Grease and tighten the steering stem
- Check the steering ball joints
- Run all tests in the dealer tool (E-Bike)

3rd Service moment

60-120 minutes

Among them: All points from service moment 1, 2, and:

- Inspection of the paintwork
- Inspection of the frame/front fork
- Inspection of the seat cushions
- Inspect the functioning and sound of the motor/gear hub
- check reflectors for any damage
- Check all electric components on their placement (E-Bike)
- Run all tests in the dealer tool (E-Bike)

Service plan

1st Service moment

- Yes/No
- Dealer:
- Mechanic:

Date:

Remarks:

.....

.....

.....

.....

2nd Service moment

- Yes/No
- Dealer:
- Mechanic:

Date:

Remarks:

.....

.....

.....

.....

3rd Service moment

- Yes/No
- Dealer:
- Mechanic:

Date:

Remarks:

.....

.....

.....

.....

Annual inspection

Date	Dealer	Mechanic	Remarks

Delivery and service form

Congratulations on your purchase of your Van Raam scooter bike. This bike is produced with utmost care. To guarantee the quality as much as possible Van Raam produces the cycles according to the ISO 9001:2015 quality standards. Van Raam has been certified by DNV GL Business Assurance BV.

You will especially enjoy your Van Raam bike when the bike is adjusted to your specifications and when the instructions in the user manual are followed. Pay special attention on the service intervals who specified in the manual of the bike.

To claim warranty and service you should always fill out this form, at least at delivery and service. This signed form declares that the end user had an instruction on the operation of the scooter bike, that the scooter bike is adjusted to the specifications of the end user and that the user manual is received.

Fill out when the scooter bike is delivered

Type Van Raam scooter bike:	
Frame number:	
Key number:	
Delivered to:	
By dealer:	
Place:	
Date:	
Signature user bike:	Signature dealer:
When available, stamp dealer:	